

APOLLO H1-6PB 安裝線路圖

解碼驅動板

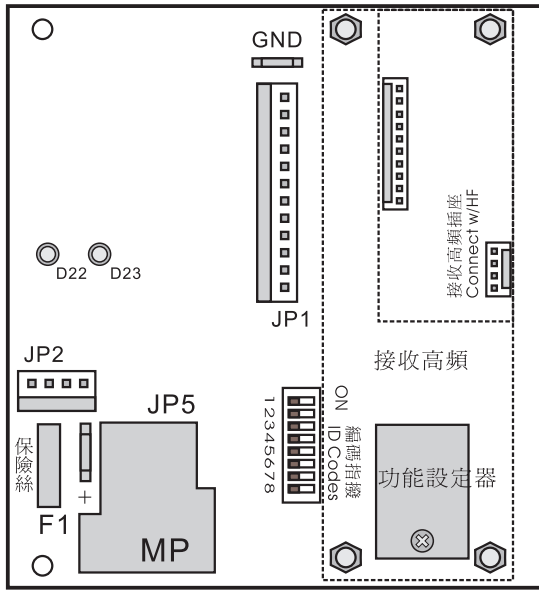

接線位置圖

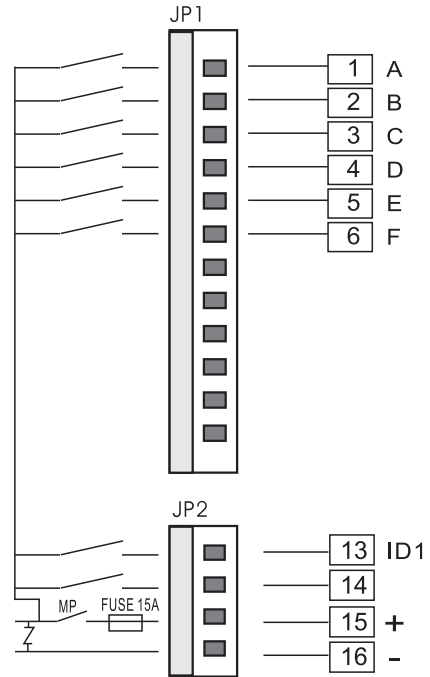

規格:

- 1.ID1動作設定為<1速聯動>.
- 2.控制電纜為2M長.
- 3.面版貼紙為油壓車專用.

接收器

發射器

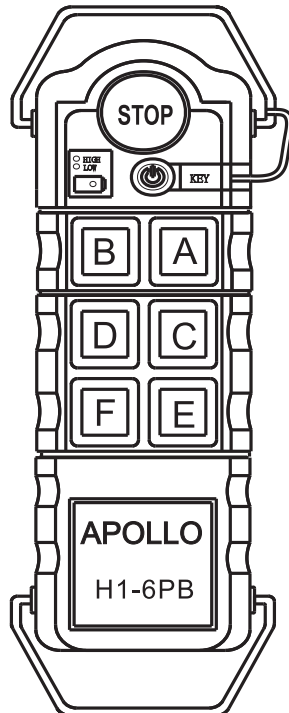
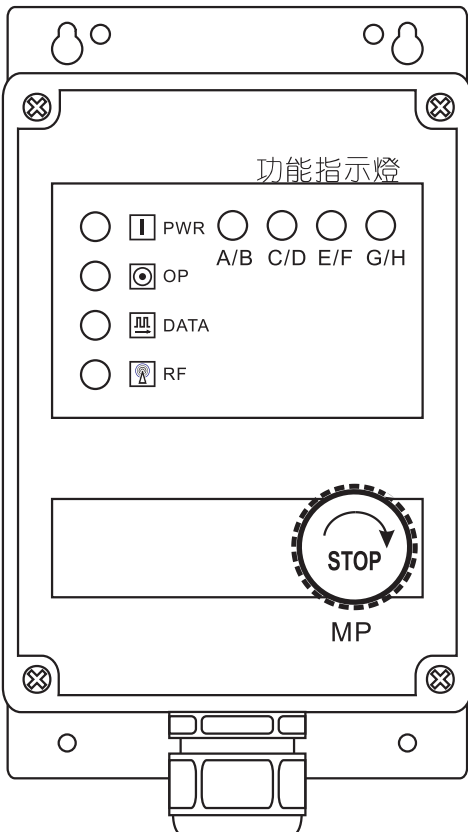

按鍵銘板 (可接受定製)

