

APOLLO mini 30 Installation Wiring Diagram

Encoder Board

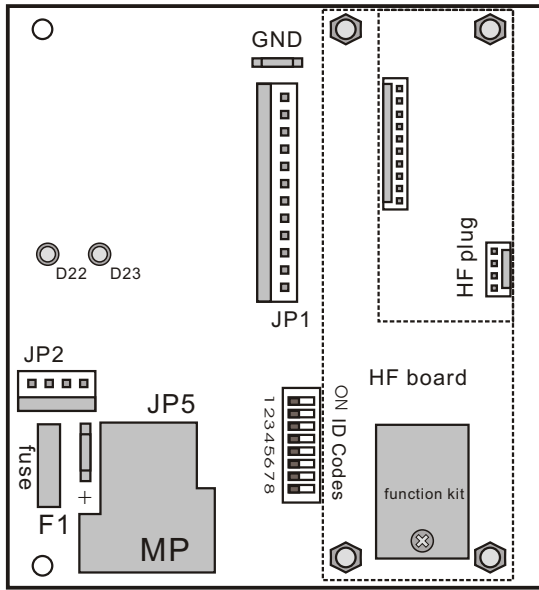

Internal wiring

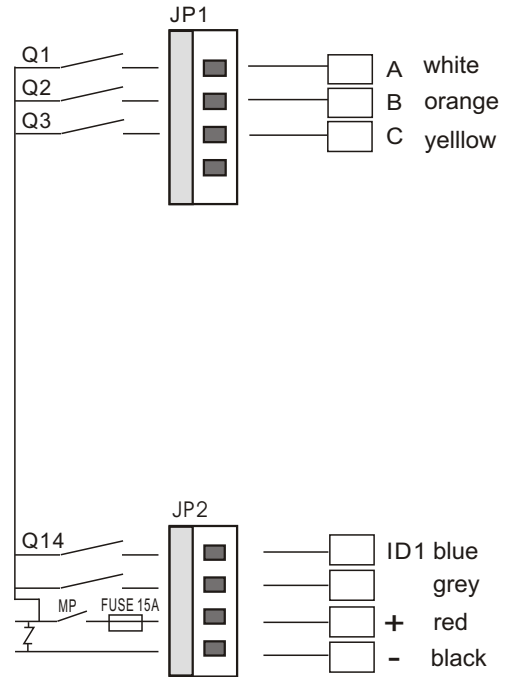

Features:

1. ID1 main relay is set for oil pump to be linked with each movement.
2. Furnished with control cable 2M long.
3. The printing illustration on the button can be custom made.
4. Each set of motion (ex.K1/K2) is set with interlock ex-work.

Receiver



Transmitter

